

# Pulse PRO



## Features

### Keypad

- Red LED
- Buzzer
- Keypad test
- Automatic DST
- Battery compartment
- Battery level test
- Buzzer silencing function
- 12 function keys
- Compatible with digital locks
- Compatible with analog locks

### Power

- 9V alkaline battery
- large battery box
- power supply

### Locks

- 2 Masters
- 3 Managers
- 49 users
- 10 Time delay override users
- Codes expiry
- Time delay 1-99 minutes
- Open window 1-19 minutes
- Silent alarm
- Remote disable opening
- Remote time delay override
- Door open alarm
- Bolt status output
- Penalty
- Dallas Keys
- Dual code mode
- Audit trail with time and date (up to 5500 events)
- Pre-programmed configurations (more than 80)
- Fully configurable by keypad
- Hotel mode
- Master reset
- Hardware reset
- ERC – Emergency Rescue Code

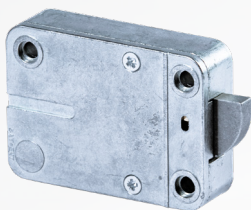

*RotoBolt*

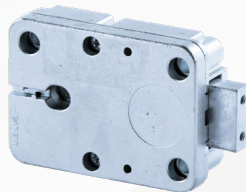

*StraightBolt*

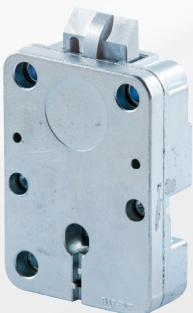

*SpringBolt*



*MotorLock*



*Motor SpringBolt*

## Pulse PRO

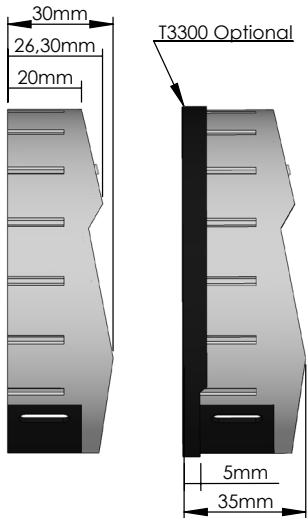
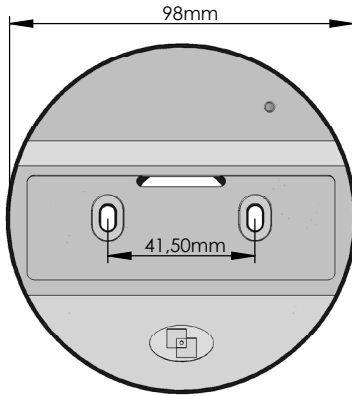

## RotoBolt

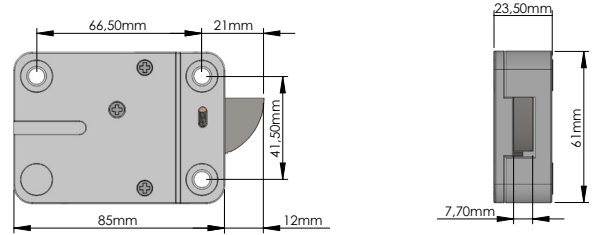

## StraightBolt

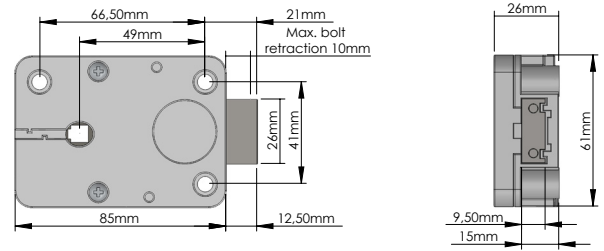

## SpringBolt

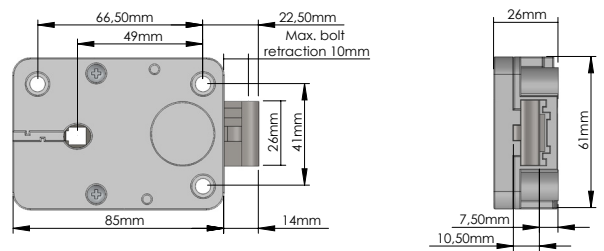

## MotorLock

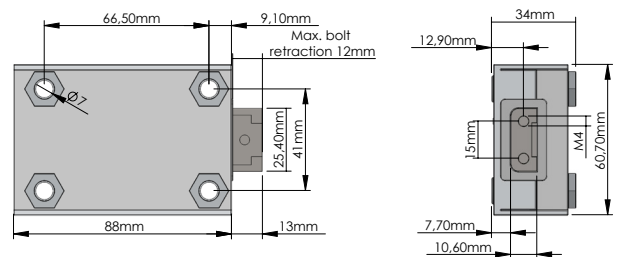

## Motor SpringBolt

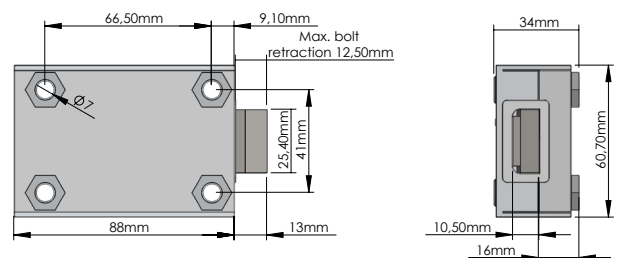

### GLOBAL HEADQUARTERS

Tecnosicurezza  
Via C. Battisti, 276  
37057 S.Giovanni Lup.(VR)  
ITALY  
info@tecnosicurezza.it  
www.tecnosicurezza.it

### USA HEADQUARTERS

Tecnosicurezza  
50, Thomas Lane  
Versailles, KY 40383  
USA  
info@usatecno.com  
www.usatecno.com

### SPAIN HEADQUARTERS

Tecnosicurezza  
C/Menor, 4 - Nave 10, Pol Ind. "La Miña"  
28770 Colmenar Viejo  
SPAIN  
info@tecnosicurezza.es  
www.tecnosicurezza.es