

Installation Manual

Premier Elite iProx

INS303-3



Texecom
Designed to Perform

Introduction

The *Premier Elite iProx* module can be installed in one of two modes:

Network Mode

The network mode allows the *Premier iProx* to be connected to the network terminals of the *Premier Elite 24/48/88/168/640* control panels. This mode provides the following facilities:

- Built in proximity reader using standard *Premier Elite* proximity tags
- Connections for optional external reader *Premier Elite External Prox*
- 26bit Wiegand interface to allow support for 3rd party access control readers
- Support for Key Seven SA840-A20 keypad
- Proximity tags/user codes are stored in the control panel
- Request To Exit (RTE) input
- Voltage free contacts (3 Amps) for connection to door strike
- Internal sounder and extension loudspeaker connections
- Can be used as an arming station or as door access only.
- Standard 7/0.2 alarm cable can be used for most installations. However, under certain conditions it may be necessary to use screened cable.



NOTE *The maximum number of tags/users codes that can be stored is dependent on the number of users available on the control panel.*

Stand-alone Mode

The stand-alone mode allows the *Premier Elite iProx* to be used as a simple door access controller. This mode provides the following facilities:

- Built in proximity reader using standard *Premier* proximity tags
- Connections for optional external reader *Premier External Prox*
- 26bit Wiegand interface to allow support for 3rd party access control readers
- Up to 10 proximity tags can be stored in the module
- Request To Exit (RTE) input
- Voltage free contacts (3 Amps) for connection to door strike
- Internal sounder and extension loudspeaker connections

PCB Layout

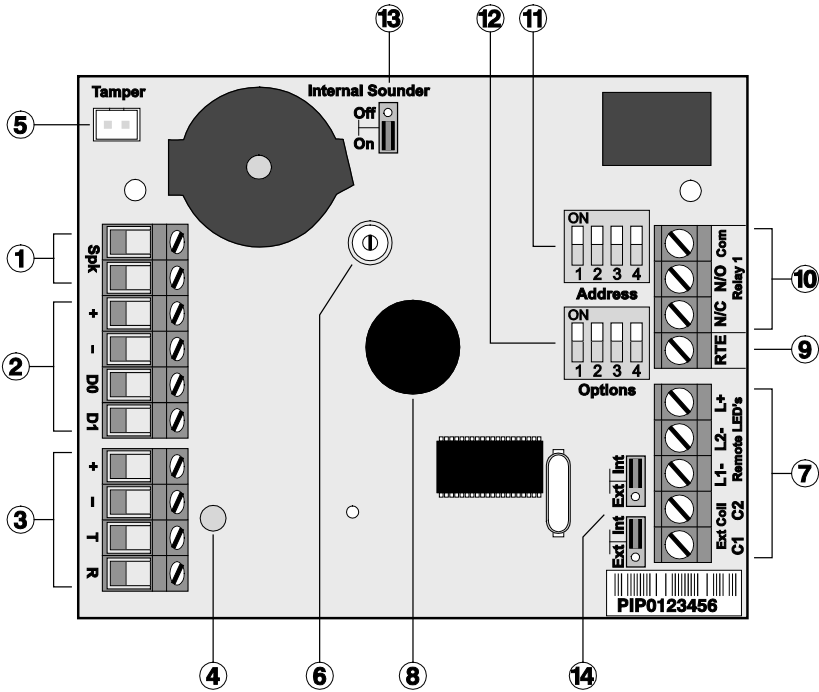

1. Extension loudspeaker terminals (16 Ohm)
2. Wiegand interface connections
3. Network terminals for connection to a control panel (Network Mode)
4. Status LED
5. Tamper switch connector
6. Volume adjustment for extension loudspeaker
7. Remote proximity coil and LED terminal connections for *Premier External Prox* unit
8. Internal proximity coil
9. Request To Exit (RTE) input (apply 0V to activate)
10. Door strike relay (voltage free change-over contacts)
11. Address/User/Door Strike time selection switches
12. Option selection switches
13. Enable/disable internal sounder jumper link
14. Internal/External coil selection jumper links

Network Mode Installation

Introduction









When the *iProx* is used in the Network mode, it uses one of the available remote keypad address slots on the system. The maximum number of keypad address slots varies depending on the control panel:

Control Panel	Max. No of Keypads
<i>Premier Elite 24</i>	4
<i>Premier Elite 48</i>	4
<i>Premier Elite 88</i>	8
<i>Premier Elite 168</i>	16
<i>Premier Elite 640</i>	64

Before installing the unit, make sure that you have a spare keypad address slot, if all keypad slots have been used it will not be possible to install the *iProx* in this mode.

Option and Address Switches for Network Mode

When installed in this mode the Option and Address switches function as follows:

12 Options					
Switch	OFF		ON		
1	Internal Prox. Disabled		Internal Prox. Enabled		
2	Normal Relay Operation		Inverted Relay Operation		
3	Sounder Disabled		Sounder Enabled		
4	Tamper Disabled		Tamper Enabled		
11 Options					
Address	DIL 1	DIL 2	DIL 3	DIL 4	
1	On/Off	Off	Off	Off	
2	Off	On	Off	Off	
3	Off	Off	On	Off	
4	Off	Off	Off	On	
5	On	Off	Off	On	
6	Off	On	Off	On	
7	Off	Off	On	On	
8	On	Off	On	On	

Using Premier Elite Proximity Tags

This configuration allows you to use the standard proximity tags that are used with the *Premier & Premier Elite* keypads. The tags **MUST** be learnt at a keypad which has a built in proximity reader. The figure below shows a typical installation:

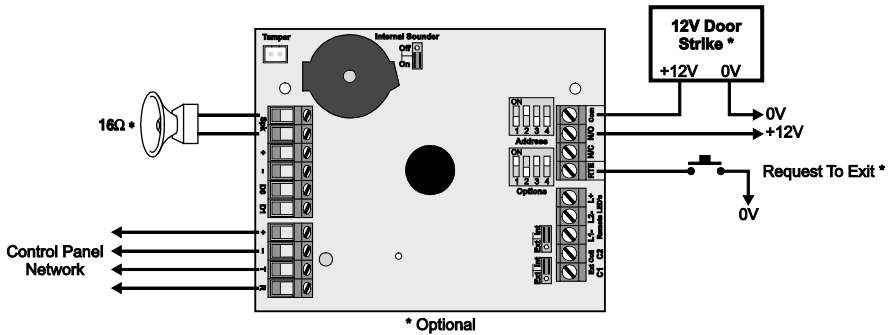

Installation

Remove all power from control panel before making any connections.

1. Install the module in the required location making sure that it is mounted away from metal objects and other cables as these can affect the performance of the unit.
2. Connect the network connections of the module to the network connections of the control panel.
3. Connect the optional devices such as the door strike, RTE button and loudspeaker.
4. Set the Internal/External coil jumper links ①④ to **Internal (Int)**.
5. Ensure that **Options** switch 1 is set to **ON** (Internal Prox. Enabled) and switches 2, 3 and 4 are set as required, see page 4.
6. Using **Address** switches set the address of the module to one of the available keypad address slots, see page 4.
7. Re-apply power to the control panel and select the engineer's programming mode.
8. Select the "Confirm Devices" option within the "Engineer Utils" menu and confirm that the module is being "seen" as a remote keypad on the system.
9. If the relay on the *iProx* is utilized, it is controlled by the relevant remote keypad output. Select the "Keypad Outputs" option within the "System Outputs" menu and program it to the required type, e.g. "Door Strike".
10. If required learn any new tags then exit the engineer's mode.
11. Check that the *iProx* and proximity tags operate correctly.

Learning Premier Elite Proximity Tags

If the system is already using *Premier* proximity tags then the existing tags will work as normal when presented to the *iProx* module. For full details on learning proximity tags refer to the control panel installation manual.

Using 3rd Party Proximity Tags

This configuration allows you to use proximity tags from other manufacturers. The proximity reader **MUST** be capable of providing the data in 26bit Wiegand format. The figure below shows a typical installation:

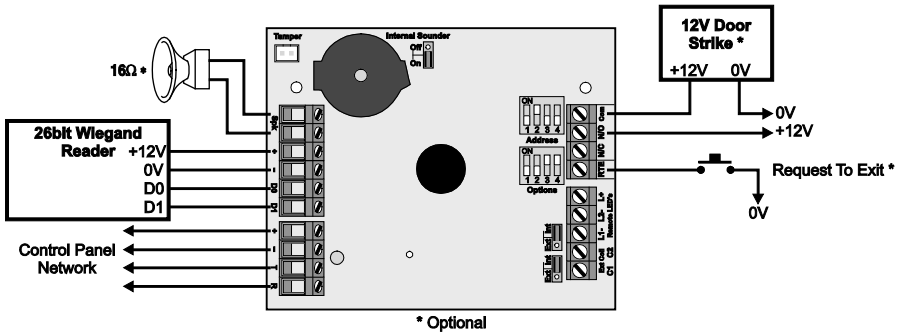

Installation

Remove all power from control panel before making any connections.

1. Install the 26bit Wiegand reader in the required location and according to the manufacturer's instructions.
2. Install the *iProx* module at least 0.5 metre away from the 26bit Wiegand reader and from other metal objects and cables.
3. Connect the network connections of the module to the network connections of the control panel.
4. Connect 26bit Wiegand reader to the *iProx* as shown above.
5. Connect the optional devices such the door strike, RTE button and speaker.
6. Ensure that **Options** switch 1 is set to **OFF** (Internal Prox. Disabled) and switches 2, 3 and 4 are set as required, see page 4.
7. Using the **Address** switches, set the address of the module to one of the available remote keypad address slots, see page 4.
8. Re-apply power to the control panel and select the engineer's programming mode.
9. Select the "Confirm Devices" option within the "Engineer Utils" menu and confirm that the module is being "seen" as a remote keypad on the system.
10. If the relay on the *iProx* is utilized, it is controlled by the relevant keypad output. Select the "Keypad Outputs" option within the "System Outputs" menu and program it to the required type, e.g. "Door Strike".
11. Learn any new tags (see below) then exit the engineer's mode.
12. Check that the *iProx* and proximity tags operate correctly.

Learning 3rd Party Tags on the Premier Elite 24/48/88/168/640

When using 3rd party tags via a Wiegand reader, the tag or card is encoded with a unique 6 digit code. This code is learnt onto the control panel and is stored separately from the user code, this allows for users to have a tag and access code with different codes. To learn 3rd party tags proceed as follows:

1. Select the "Setup Users" menu on the control panel.
2. Enter the user number that you want to assign the tag or card.
3. Press **[Yes]** and program the user code and options as required, when the remote keypad displays "Add TAG to User?". Press **[2]** to select Import TAG.
4. The remote keypad will now display "IMPORTING TAG Present TAG Now".
5. Present the tag or card to the Wiegand reader, you will hear an acceptance tone when the tag is imported successfully.
6. Repeat steps 2 - 5 for other tags or cards

When installed in the Network mode, the operation of the iProx is as follows:

- When a valid proximity tag is presented to the module or via the Wiegand reader you will hear a beep from the internal sounder (if the Internal Sounder jumper is set to ON). The status LED will momentarily change from green to yellow indicating a valid tag read. If the alarm system is in a disarmed state the control panel will start the exit sequence. The exit tone will be generated if the "Sounder Enabled" switch 3 is ON. The user should leave premises as normal. If the alarm system is armed or in entry mode the system will disarm on presentation of a valid tag.
- When an invalid proximity tag is presented to the module or via the Wiegand reader you will hear a beep from the internal sounder (if the Internal Sounder jumper is set to ON). The status LED will momentarily change from green to yellow, but the status of the alarm is not affected.
- The Door Strike relay is controlled by the control panel and will activate when the relevant remote keypad output is active.
- If the RTE input is activated the Door Strike relay is activated for 5 seconds.



To restrict operation of the iProx to door strike please see the control panel installation manual.

Using the Key Seven SA840-A20 Keypad

This configuration allows you to integrate the SA840-A20 keypad manufactured by Key Seven with the Premier Elite 24/48/88/168/640 control panels. The figure below shows a typical installation:

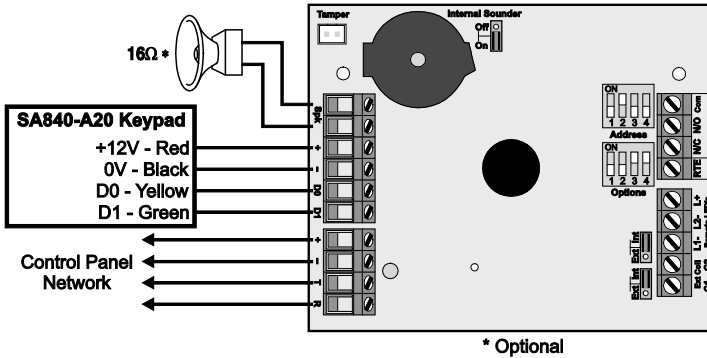

Installation

Remove all power from control panel before making any connections.

1. Install the SA840-A20 keypad in the required location and according to the manufacturer's instructions.
2. Program the SA840-A20 output format for Wiegand (format No 2).
3. Install the *iProx* module at least 0.5 metre away from other metal objects and cables.
4. Connect the network connections of the module to the network connections of the control panel.
5. Connect SA840-A20 keypad to the *iProx* as shown above.
6. Ensure that **Options** switch 1 is set to **OFF** (Internal Prox. Disabled) and switches 2, 3 and 4 are set as required, see page 4.
7. Using the **Address** switch set the address of the module to one of the available remote keypad address slots, see page 4.
8. Re-apply power to the control panel and select the engineer's programming mode.
9. Select the "Confirm Devices" option within the "Engineer Utils" menu and confirm that the module is being "seen" as a remote keypad on the system.
10. If the relay on the *iProx* is utilized, it is controlled by the relevant keypad output. Select the "Keypad Outputs" option within the "System Outputs" menu and program it to the required type.
11. Setup user codes as required then exit the engineer's mode.
12. Check that the SA840-A20 operate correctly.

SA840-A20 Keypad Operation

When the *Premier iProx* is installed with an SA840-A20 keypad the operation of the alarm system is as follows:

- If a valid user code is entered followed by the **[P]** key during the exit sequence the remaining exit time is truncated and the system arms immediately.
- If a valid user code is entered followed by the **[P]** key whilst the system is armed, the entry timer is started. The user must enter the premises via the designated entry route and disarm the system using the standard *Premier* remote keypad.
- If a valid user code is entered followed by the **[P]** key whilst the system is disarmed, the system status is unaffected.
- The Door Strike relay is controlled by the control panel and will activate when the relevant remote keypad output is active.
- If the RTE input is activated the Door Strike relay is activated for 5 seconds.

Installing a Premier Elite External Prox

The *Premier Elite External Prox* provides external proximity tag reading capabilities when used with the *iProx* module. The figure below shows the connection details:

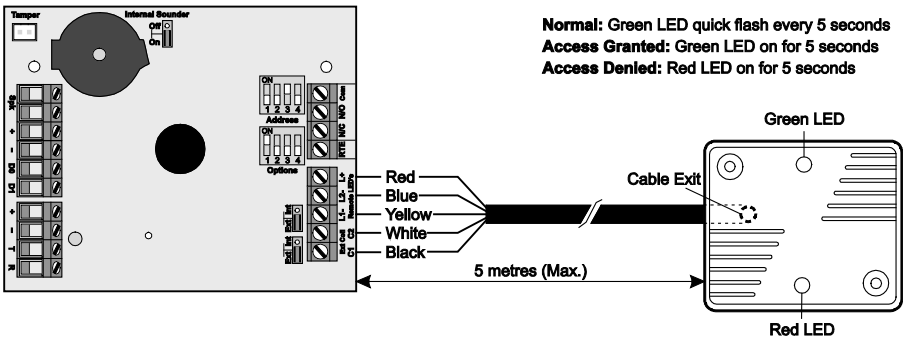

Installation

Remove all power from module panel before making any connections.

1. Install the *External Prox* in the required location.
2. Ensure that **Options** switch 1 is set to **ON** (Internal Prox. Enabled) and switches 2, 3 and 4 are set as required, see page 4.
3. Set the Internal/External coil jumper links ①④ to **External** (Ext).











Stand-alone Mode Installation

Introduction

When the *iProx* is used in the Stand-alone mode, it allows the unit to be used as a simple single door access controller. The module can learn and store up to 10 proximity tags, which can be either the *Premier Elite* proximity tags or 3rd party proximity tags or cards via the 26bit Wiegand interface.

Option Switches for Network Mode

When installed in this mode the Options and Address switches function as follows:

12 Options						
Switch	Off					On
1	Internal Prox. Disabled					Internal Prox. Enabled
2	Normal Relay Operation					Inverted Relay Operation
3	Delete Tag Mode					Add Tag Mode
4	Normal Operation					Program Mode
11 Address – User No/Door Strike Time						
No/Secs	DIL 1	DIL 2	DIL 3	DIL 4		
1	On/Off	Off	Off	Off		
2	Off	On	Off	Off		
3	Off	Off	On	Off		
4	Off	Off	Off	On		
5	On	Off	Off	On		
6	Off	On	Off	On		
7	Off	Off	On	On		
8	On	Off	On	On		
9	Off	On	On	On		
10	On	On	On	On		

Using Premier Proximity Tags

This configuration allows you to use the standard proximity tags that are used with the *Premier LCDP* and *LCDLP* keypads. The figure below shows a typical installation:

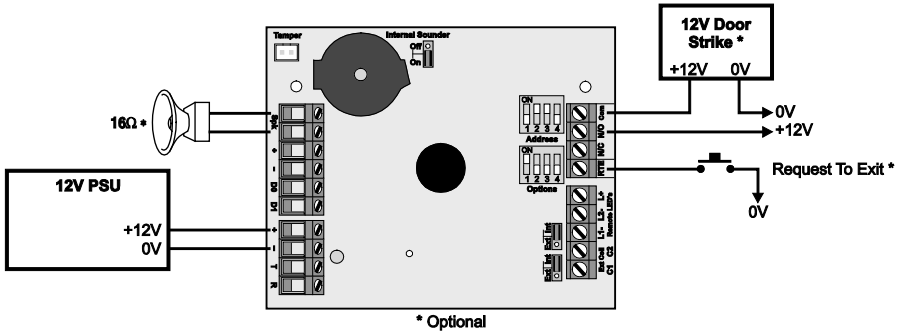

Installation

Remove all power from power supply before making any connections.

1. Install the module in the required location making sure that it is mounted away from metal objects and other cables as these can affect the performance of the unit.
2. Connect the +12V and 0V from the power supply to the + and - network connections of the module.
3. Connect the optional devices such as the, RTE button and speaker.
4. Set the Internal/External coil jumper links (Ⓢ) to **Internal (Int)**.
5. Ensure that **Options** switch 1 is set to **ON** (Internal Prox. Enabled) and switch 2 is set as required, see page 10.
6. Ensure that **Options** switch 3 and 4 are initially set to **OFF**, see page 10.
7. Re-apply power to the power supply.
8. Learn or program tags.
9. Check that the *Premier iProx* and proximity tags operate correctly.

Learning Existing Premier Elite Proximity Tags

If the system is already using *Premier* proximity tags for the operation of the alarm system, then the existing tags can be learnt into the *iProx* module. This will allow users with the *Premier Elite* proximity tags to operate both the door access control and the alarm system with same tag.

1. Set **Options** switch 3 to **ON** (Add Tag Mode), see page 10.
2. Set **Options** switch 4 to **ON** (Program Mode), see page 10. The status LED will flash green when the module is in program and add tag mode.
3. Set the user number 1-10 that you want to assign the tag to, using the **Address** switches, see page 10.
4. Present the tag to the centre of the module, an acceptance tone is generated and the tag data is stored in the module for the selected user.
5. Repeat steps 3 and 4 if other tags are to be learnt.
6. Set **Options** switch 4 to **OFF** (Normal Operation), see page 10. The status LED will light red when the module is in normal operation.
7. Set the Door Strike time to the required setting using **Address** switches, see page 10.

Learning New Premier Elite Proximity Tags

When leaving the factory, the proximity tags are blank. When using this method of learning the tags, the *iProx* module generates a unique 6 digit code that is stored both in the module and tag. If the tag was already programmed the data will be overwritten.

1. Set **Options** switch 3 to **ON** (Add Tag Mode), see page 10.
2. Set **Options** switch 4 to **ON** (Program Mode), see page 10. The status LED will flash green when the module is in program and add tag mode.
3. Set the user number 1-10 that you want to assign the tag to, using the **Address** switches, see page 10.
4. Press and hold the tamper switch until the unit starts beeping.
5. Present the tag to the centre of the module, an acceptance tone is generated and the tag is programmed for the selected user.
6. Repeat steps 3, 4 and 5 if other tags are to be learnt.
7. Set **Options** switch 4 to **OFF** (Normal Operation), see page 10. The status LED will light red when the module is in normal operation.
8. Set the Door Strike time to the required setting using the **Address** switches, see page 10.

Deleting Individual Premier Elite Proximity Tags

If a tag is no longer required it can be deleted from the module as follows:

1. Set **Options** switch 3 to **OFF** (Delete Tag Mode), see page 10.
2. Set **Options** switch 4 to **ON** (Program Mode), see page 10. The status LED will flash red when the module is in program and delete tag mode.
3. Set the user number 1-10 that you want to delete, using the **Address** switches, see page 10.
4. Press and hold the tamper switch until the unit generates an acceptance tone.
5. Repeat step 3 and 4 if other tags are to be deleted.
6. Set **Options** switch 4 to **OFF** (Normal Operation), see page 10. The status LED will light red when the module is in normal operation.
7. Set the Door Strike time to the required setting using the **Address** switches, see page 10.

Deleting All Premier Elite Proximity Tags

This procedure offers a fast method of deleting all programmed tags from the module:

1. Set **Options** switch 3 to **OFF** (Delete Tag Mode), see page 10.
2. Set **Options** switch 4 to **ON** (Program Mode), see page 10. The status LED will flash red when the module is in program and delete tag mode.
3. Set all **Address** switches to **OFF**.
4. Press and hold the tamper switch, after 3 seconds the unit will start to beep every second. After 10 seconds the unit generates an acceptance tone and all tags are deleted.

Using 3rd Party Proximity Tags

This configuration allows you to use proximity tags from other manufacturers. The proximity reader **MUST** be capable of providing the data in 26bit Wiegand format. The figure below shows a typical installation:

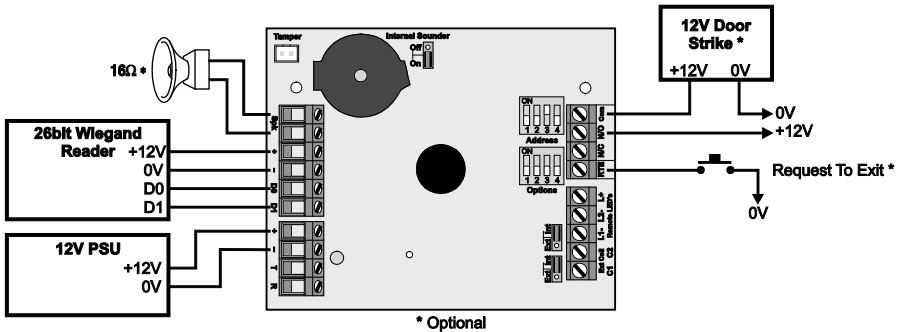

Installation

Remove all power from power supply before making any connections.

1. Install the 26bit Wiegand reader in the required location and according to the manufacturers instructions.
2. Fix the *iProx* module at least 0.5 metre away from the 26bit Wiegand reader and from other metal objects and cables.
3. Connect the +12V and 0V from the power supply to the + and - network connections of the module.
4. Connect the optional devices such the, RTE button and speaker.
5. Ensure that **Options** switch 1 is set to **OFF** (Internal Prox. Disabled) and switch 2 is set as required, see page 10.
6. Ensure that **Options** switch 3 and 4 are initially set to **OFF**, see page 10.
7. Re-apply power to the power supply.
8. Learn the 3rd party tags or cards (see below).
9. Check that the iProx and proximity tags operate correctly.

Learning 3rd Party Proximity Tags or Cards

To learn 3rd party tags or cards in stand-alone mode proceed as follows:

1. Set **Options** switch 3 to **ON** (Add Tag Mode), see page 10.
2. Set **Options** switch 4 to **ON** (Program Mode), see page 10. The status LED will flash green when the module is in program and add tag mode.
3. Set the user number 1-10 that you want to assign the tag to, using the **Address** switches, see page 10.
4. Present the tag to the Wiegand reader, an acceptance tone is generated and the tag data is stored in the module for the selected user.
5. Repeat steps 3 and 4 if other tags are to be learnt.
6. Set **Options** switch 4 to **OFF** (Normal Operation), see page 10. The status LED will light red when the module is in normal operation.
7. Set the Door Strike time to the required setting using the **Address** switches, see page 6.

Stand-alone Mode Operation

When installed in the Stand-alone mode, the operation of the module is as follows:

- When a valid tag is presented to the module or via the Wiegand reader you will hear an acceptance tone from the speaker (if connected) and the internal sounder (if the Internal Sounder jumper is set to ON). The status LED will change from red to green and the Door Strike relay is activated for the selected time (controlled by the Address switches).
- When an invalid tag is presented to the module or via Wiegand reader you will hear an error tone from the internal sounder (if the Internal Sounder jumper is set to ON). The status LED will momentarily light yellow and the Door Strike relay is NOT activated.
- If the RTE input is activated the Door Strike relay is activated for the selected time (controlled by the Address switches).

Specifications

Electrical

Supply:	9 to 14VDC
Current Consumption:	35mA without internal Prox enabled 85mA with internal Prox enabled
Door Strike Relay:	Voltage free changeover @3A
Request to Exit (RTE):	Active low
Loudspeaker Output:	16Ohm
Wiegand Interface:	26bit

Environmental

Operating Temperature:	-10°C to +55°C
Maximum Humidity:	95% non-condensing

Physical

Dimensions:	133mm x 78mm x 20mm
Packed Weight:	140g (approx.)

Standards



2004/108/EC (CE directive): Hereby, Texecom declares that this device is in compliance with the essential requirements and other relevant provisions of Directive 2004/108/EC.



WEEE Directive: 2002/96/EC (WEEE directive): Products marked with this symbol cannot be disposed of as unsorted municipal waste in the European Union. For proper recycling, return this product to your local supplier upon the purchase of equivalent new equipment, or dispose of it at designated collection points. For more information see: www.recyclethis.info.

RoHS Directive: 2002/95/EC RoHS Compliant. Hereby, Texecom declares that this device does not contain lead, mercury, cadmium, hexavalent chromium, polybrominated biphenyls (PBB) or polybrominated depheny ethers (PBDE) in more than the percentage specified by EU directive 2002/95/EC, except exemptions stated in EU directive 2002/95/EC annex.

This product is a Type B Moveable device and is suitable for use in systems designed to comply with EN 50131-1, EN50131-3 and PD6662 at Grade 3 and Environmental Class II.

Warranty

All Texecom products are designed for reliable, trouble-free operation. Quality is carefully monitored by extensive computerised testing. As a result the *iProx* module is covered by a two-year warranty against defects in material or workmanship. As the *iProx* module is not a complete alarm system but only a part thereof, Texecom cannot accept responsibility or liability for any damages whatsoever based on a claim that the *iProx* module failed to function correctly. Due to our policy of continuous improvement Texecom reserve the right to change specification without prior notice.

Premier is a trademark of Texecom Ltd

Texecom

Designed to Perform

Texecom Limited, Bradwood Court, St. Crispin Way, Haslingden, Lancashire BB4 4PW,
England.

Technical Support:

UK Customers Tel: 08456 300 600

(Calls charged at 3.36 pence per minute from a BT landline. Calls from other networks may vary.)

International Customers Tel: +44 1706 233875

Email: techsupport@texe.com

© Texecom Limited 2012

INS303-3

