

Instruction Manual
Premier Elite IR

Texecom
Designed to Perform

MADE IN ENGLAND

INS543-2

6 - Premier Elite IR

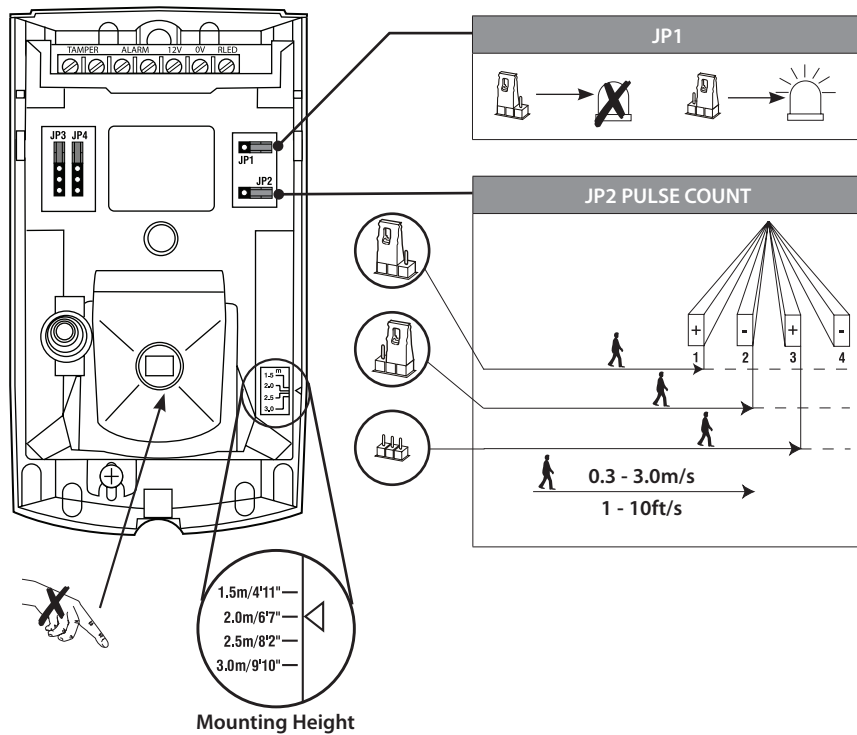
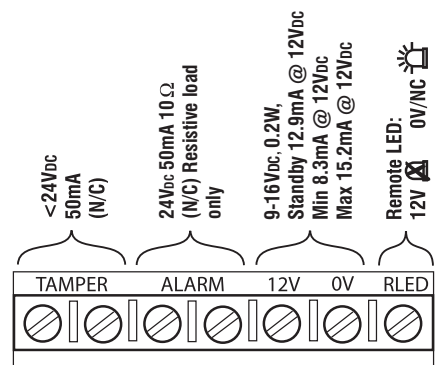

8

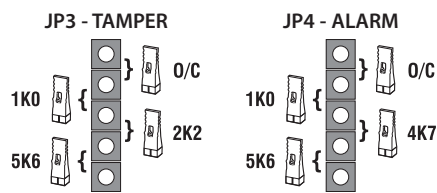
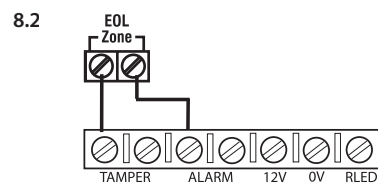
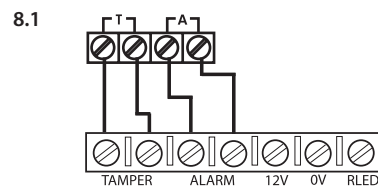
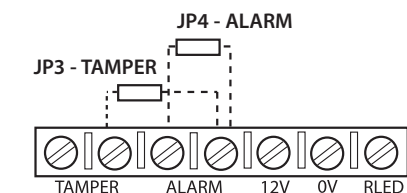

Panel Support	Texecom	Cooper Menvier	Honeywell	DSC
Alarm EOL	4K7	4K7	1K	5K6
Tamper EOL	2K2	2K2	1K	5K6

9

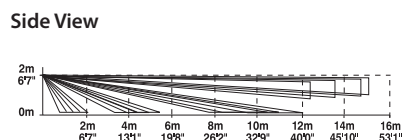
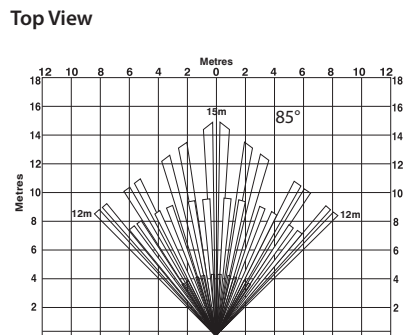

7

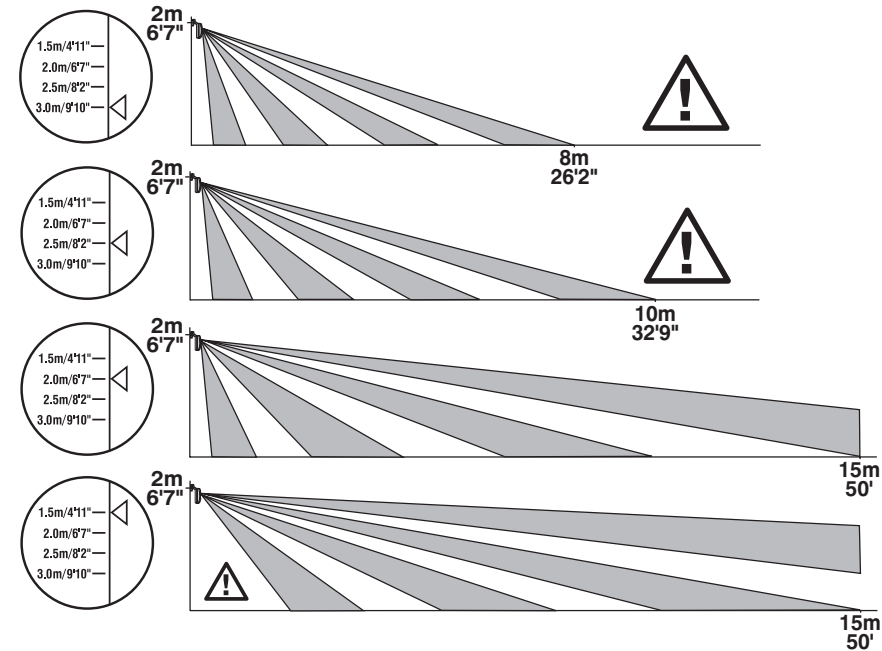

10

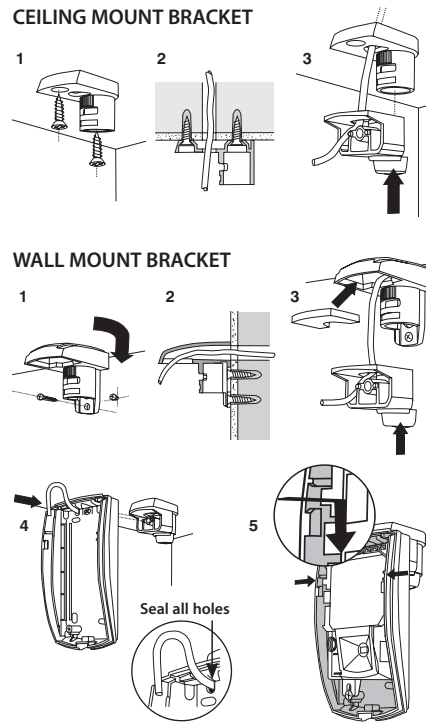

Specifications	
Product Type	Elite IR - AFD0000
Detector	PIR
Signal processing	Analogue
Range	15 m
Optical	Fresnel Lens
Input power	9Vdc to 15Vdc (15 Vdc nominal @ 10.6 mA)
Detector start-up time	60 seconds
Normal current consumption (mA)	12.9
Current consumption in Alarm (mA)	15.2
Max current consumption (mA)	15.2
Remote LED	12V O/V/NC
Mounting height	Min. 1.5 m (4.1 ft), Max. 3.1 m (10 ft.)
Target speed range	30 cm/s to 3 m/s (1 ft/s to 10 ft/s)
Alarm relay	$<24\text{Vdc}$ 50mA (N/C) $10\ \Omega$
Tamper relay	$<24\text{Vdc}$ 50mA (N/C)
Alarm time	>2 seconds
Operating temperature	-10°C to $+55^\circ\text{C}$ (14°F to 130°F)
Dimensions (HxWxD)	112mm x 60mm x 40mm
Relative humidity	Max. 95%
Weight	150g
Power supply	Rated 94HB

Contact information: www.texe.com



Certificate Number: FM 35285

The Premier Elite detectors are protected by UK & International Registered Designs. Registered Design No's: 3004997, 3004260 & 3004261. Premier Elite is a Trademark of Texecom Ltd. © 2011 Texecom Ltd.



EN: Installation Sheet

Product description

The Premier Elite IR is designed to detect movement of an intruder and activate an alarm control panel. The product is intended to be connected to a listed burglar compatible control unit or a power supply that has a voltage output range of between 9 to 15 VDC and provides a minimum of 4 hours of standby power.

1. Installation guidelines

The technology used in these detectors resists false alarm hazards. However, avoid potential causes of instability such as (see Fig. 1).

2. Opening the detector

- Unwind the screw at the base of the detector until loose; the screw will be retained in the product (see Fig. 2, step 1).
- Lift detector lid out from the base and off the lugs at the top (see Fig. 2, step 2).

3. Detector knockouts

4. Mounting the detector

5. Coverage & pick-up

6. Premier Elite IR set-up

- Set the mounting height by adjusting the position of the PCB.
- Wire the detector.
- Select the desired jumper settings.

7. Altering Coverage (at 2m Mounting height)

8. End of Line Jumper links

- The jumper links JP3 and JP4 are used to select resistances for End-of-Line (EOL) wiring applications.
- JP3: Selects the End-of-Line resistance. Equivalent to wiring a resistor of the selected value as shown.
- JP4: Selects the resistance across the alarm relay. Equivalent to wiring a resistor of the selected value as shown.
- If EOL wiring is not used, the headers should be left in the default (O/C) position.
- If the required resistance values are not available, leave the headers in the O/C position and wire in external resistors as normal.

8.1. Double Pole (jumper links not used)

8.2. Dual End-of-Line (DEOL)

9. Coverage Pattern

10. Bracket installation (Brackets available separately, Part No. AFU-0004-2)

Regulatory information

Supplier: Texecom Ltd, St. Crispin Way, Haslingden, Lancashire, BB4 4PW, UK.

Weee Directive: 2002/96/EC (WEEE directive): Products marked with this symbol cannot be disposed of as unsorted municipal waste in the European Union. For proper recycling, return this product to your local supplier upon the purchase of equivalent new equipment, or dispose of it at designated collection points. For more information see: www.recyclethis.info.

RoHS Directive: 2002/95/EC RoHS Compliant. Hereby, Texecom declares that this device does not contain lead, mercury, cadmium, hexavalent chromium, polybrominated biphenyls (PBB) or polybrominated depheny ethers (PBDE) in more than the percentage specified by EU directive 2002/95/EC, except exemptions stated in EU directive 2002/95/EC annex.

CE Directive: 2004/108/EC (CE directive): Hereby, Texecom declares that this device is in compliance with the essential requirements and other relevant provisions of Directive 2004/108/EC.

Maintenance: Test yearly by the installer

Warranty: 10 year replacement warranty

Security grade: EN Grade 2

Environmental class: Class II

Standards: EN50131-2-2

The Premier Elite IR is not a complete alarm system, but only its part. Therefore Texecom does not accept any responsibility or liability for any damage that is claimed to be a result of an incorrect functioning of the Premier Elite IR detector. Texecom reserves the right to change the specification without a prior notice.

